

Silicon Controlled Rectifiers Reverse Blocking Triode Thyristors

... designed for industrial and consumer applications such as temperature, light and speed control; process and remote controls; warning systems; capacitive discharge circuits and MPU interface.

- Center Gate Geometry for Uniform Current Density
- All Diffused and Glass-Passivated Junctions for Parameter Uniformity and Stability
- Small, Rugged, Thermowatt Construction for Low Thermal Resistance, High Heat Dissipation and Durability
- Low Trigger Currents, 200 μ A Maximum for Direct Driving from Integrated Circuits

MCR310 Series

SCRs
10 AMPERES RMS
400 thru 800 VOLTS

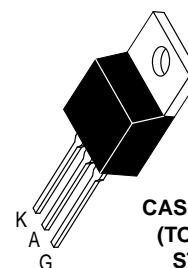

CASE 221A-09
(TO-220AB)
STYLE 3

MAXIMUM RATINGS ($T_J = 25^\circ\text{C}$ unless otherwise noted.)

Rating	Symbol	Value	Unit
Peak Repetitive Forward and Reverse Blocking Voltage ⁽¹⁾ ($T_J = -40$ to 110°C) (1/2 Sine Wave, $R_{GK} = 1 \text{ k}\Omega$)	V_{DRM} or V_{RRM}		Volts
MCR310-6		400	
MCR310-8		600	
MCR310-10		800	
On-State RMS Current ($T_C = 75^\circ\text{C}$)	$I_T(\text{RMS})$	10	Amps
Peak Non-repetitive Surge Current (1/2 Cycle, 60 Hz, $T_J = -40$ to 110°C)	I_{TSM}	100	Amps
Circuit Fusing ($t = 8.3 \text{ ms}$)	I^2t	40	A^2s
Peak Gate Voltage ($t \leq 10 \mu\text{s}$)	V_{GM}	± 5	Volts
Peak Gate Current ($t \leq 10 \mu\text{s}$)	I_{GM}	1	Amp
Peak Gate Power ($t \leq 10 \mu\text{s}$)	P_{GM}	5	Watts
Average Gate Power	$P_{G(AV)}$	0.75	Watt
Operating Junction Temperature Range	T_J	-40 to $+110$	$^\circ\text{C}$
Storage Temperature Range	T_{stg}	-40 to $+150$	$^\circ\text{C}$
Mounting Torque	—	8	in.-lb.

THERMAL CHARACTERISTICS

Characteristic	Symbol	Max	Unit
Thermal Resistance, Junction to Case	$R_{\theta JC}$	2.2	$^\circ\text{C}/\text{W}$
Thermal Resistance, Junction to Ambient	$R_{\theta JA}$	60	$^\circ\text{C}/\text{W}$

1. V_{DRM} and V_{RRM} for all types can be applied on a continuous basis. Ratings apply for zero or negative gate voltage; however, positive gate voltage shall not be applied concurrent with negative potential on the anode. Blocking voltages shall not be tested with a constant current source such that the voltage ratings of the devices are exceeded.

REV 1

MCR310 Series

ELECTRICAL CHARACTERISTICS ($T_C = 25^\circ\text{C}$, $R_{GK} = 1\text{ k}\Omega$ unless otherwise noted)

Characteristic		Symbol	Min	Typ	Max	Unit
Peak Forward Blocking Current ⁽¹⁾ ($T_J = 110^\circ\text{C}$, $V_D = \text{Rated } V_{DRM}$)	$T_C = 110^\circ\text{C}$	I_{DRM}	—	—	500	μA
	$T_C = 25^\circ\text{C}$		—	—	10	μA
Peak Reverse Blocking Current ⁽¹⁾ ($T_J = 110^\circ\text{C}$, $V_R = \text{Rated } V_{RRM}$)	$T_C = 110^\circ\text{C}$	I_{RRM}	—	—	500	μA
	$T_C = 25^\circ\text{C}$		—	—	10	μA
On-State Voltage ($I_{TM} = 20\text{ A Peak}$, Pulse Width $\leq 1\text{ ms}$, Duty Cycle $\leq 2\%$)		V_{TM}	—	1.7	2.2	Volts
Gate Trigger Current, Continuous dc ⁽²⁾ ($V_D = 12\text{ V}$, $R_L = 100\ \Omega$)		I_{GT}	—	30	200	μA
Gate Trigger Voltage, Continuous dc ($V_D = 12\text{ V}$, $R_L = 100\ \Omega$) ($V_D = \text{Rated } V_{DRM}$, $R_L = 10\text{ k}\Omega$, $T_J = 110^\circ\text{C}$)		V_{GT}	—	0.5	1.5	Volts
			0.1	—	—	
Holding Current ($V_D = 12\text{ V}$, $I_{TM} = 100\text{ mA}$)		I_H	—	—	6	mA
Critical Rate of Rise of Forward Blocking Voltage ($V_D = \text{Rated } V_{DRM}$, $T_J = 110^\circ\text{C}$, Exponential Waveform)		dv/dt	—	10	—	V/ μs
Gate Controlled Turn-On Time ($V_D = \text{Rated } V_{DRM}$, $I_{TM} = 20\text{ A}$, $I_G = 2\text{ mA}$)		t_{gt}	—	1	—	μs

1. Ratings apply for negative gate voltage or $R_{GK} = 1\text{ k}\Omega$. Devices shall not have a positive gate voltage concurrently with a negative voltage on the anode. Devices should not be tested with a constant current source for forward and reverse blocking capability such that the voltage applied exceeds the rated blocking voltage.
2. Does not include R_{GK} current.

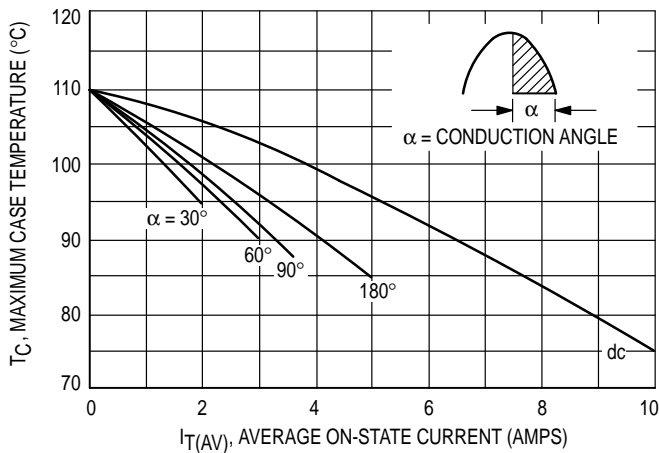

Figure 1. Average Current Derating

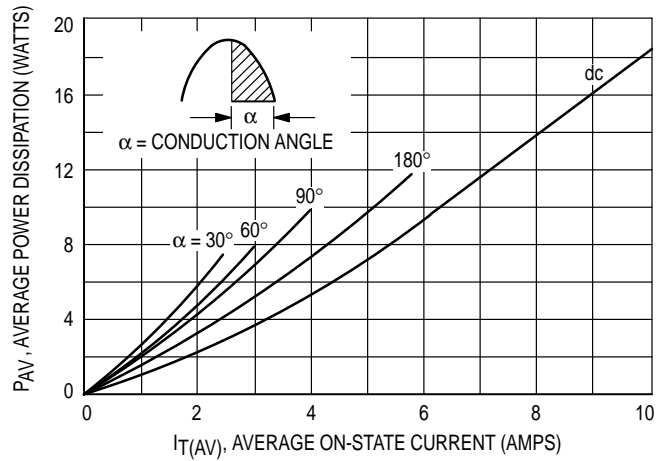

Figure 2. On-State Power Dissipation

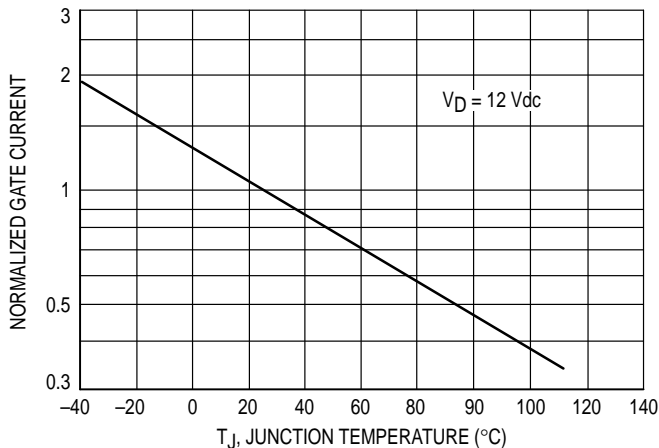

Figure 3. Normalized Gate Current

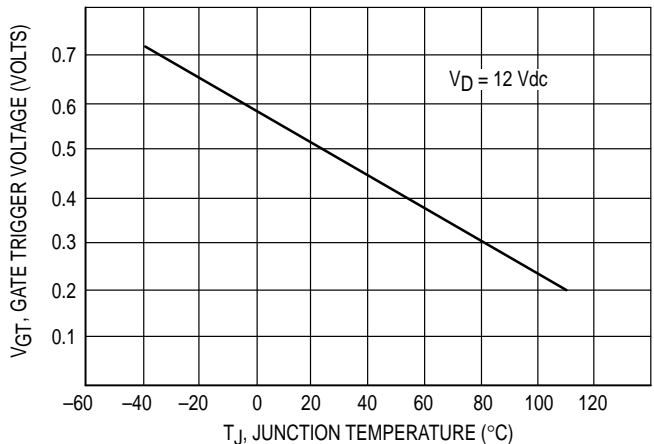
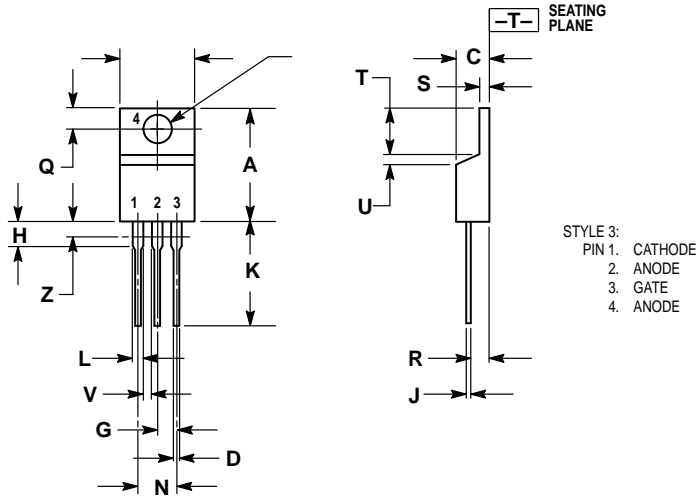

Figure 4. Gate Voltage

PACKAGE DIMENSIONS



- NOTES:
1. DIMENSIONING AND TOLERANCING PER ANSI Y14.5M, 1982.
 2. CONTROLLING DIMENSION: INCH.
 3. DIMENSION Z DEFINES A ZONE WHERE ALL BODY AND LEAD IRREGULARITIES ARE ALLOWED.

DIM	INCHES		MILLIMETERS	
	MIN	MAX	MIN	MAX
A	0.570	0.620	14.48	15.75
B	0.380	0.405	9.66	10.28
C	0.160	0.190	4.07	4.82
D	0.025	0.035	0.64	0.88
F	0.142	0.147	3.61	3.73
G	0.095	0.105	2.42	2.66
H	0.110	0.155	2.80	3.93
J	0.018	0.025	0.46	0.64
K	0.500	0.562	12.70	14.27
L	0.045	0.060	1.15	1.52
N	0.190	0.210	4.83	5.33
Q	0.100	0.120	2.54	3.04
R	0.080	0.110	2.04	2.79
S	0.045	0.055	1.15	1.39
T	0.235	0.255	5.97	6.47
U	0.000	0.050	0.00	1.27
V	0.045	—	1.15	—
Z	—	0.080	—	2.04

STYLE 3:
PIN 1. CATHODE
2. ANODE
3. GATE
4. ANODE

MCR310 Series

Motorola reserves the right to make changes without further notice to any products herein. Motorola makes no warranty, representation or guarantee regarding the suitability of its products for any particular purpose, nor does Motorola assume any liability arising out of the application or use of any product or circuit, and specifically disclaims any and all liability, including without limitation consequential or incidental damages. "Typical" parameters which may be provided in Motorola data sheets and/or specifications can and do vary in different applications and actual performance may vary over time. All operating parameters, including "Typicals" must be validated for each customer application by customer's technical experts. Motorola does not convey any license under its patent rights nor the rights of others. Motorola products are not designed, intended, or authorized for use as components in systems intended for surgical implant into the body, or other applications intended to support or sustain life, or for any other application in which the failure of the Motorola product could create a situation where personal injury or death may occur. Should Buyer purchase or use Motorola products for any such unintended or unauthorized application, Buyer shall indemnify and hold Motorola and its officers, employees, subsidiaries, affiliates, and distributors harmless against all claims, costs, damages, and expenses, and reasonable attorney fees arising out of, directly or indirectly, any claim of personal injury or death associated with such unintended or unauthorized use, even if such claim alleges that Motorola was negligent regarding the design or manufacture of the part. Motorola and  registered trademarks of Motorola, Inc. Motorola, Inc. is an Equal Opportunity/Affirmative Action Employer.

Mfax is a trademark of Motorola, Inc.

How to reach us:

USA/EUROPE/Locations Not Listed: Motorola Literature Distribution;
P.O. Box 5405, Denver, Colorado 80217. 1-303-675-2140 or 1-800-441-2447

JAPAN: Motorola Japan Ltd.; SPD, Strategic Planning Office, 141,
4-32-1 Nishi-Gotanda, Shinagawa-ku, Tokyo, Japan. 81-3-5487-8488

Customer Focus Center: 1-800-521-6274

Mfax™: RMFAX0@email.sps.mot.com – TOUCHTONE 1-602-244-6609
Motorola Fax Back System – US & Canada ONLY 1-800-774-1848
– <http://sps.motorola.com/mfax/>

ASIA/PACIFIC: Motorola Semiconductors H.K. Ltd.; Silicon Harbour Centre,
2, Dai King Street, Tai Po Industrial Estate, Tai Po, N.T., Hong Kong.
852-26629298

HOME PAGE: <http://motorola.com/sps/>



MOTOROLA



MCR310/D